



User Manual

SUPERSOUND MICRO

DAB/DAB+ / FM

Safety instructions

Please store this instruction manual for future reference.

WARNING: To reduce the risk of fire or electric shock, do not expose this apparatus to rain or moisture. The apparatus shall not be exposed to dripping or splashing and that objects filled with liquids, such as vases, shall not be placed on apparatus.

WARNING: The direct plug-in adapter is used as disconnect device, the disconnect device shall remain readily operable.



- This lightning flash with arrowhead symbol within an equilateral triangle is intended to alert the user to the presence of non-insulated “dangerous voltage” within the product’s enclosure that may be of sufficient magnitude to constitute a risk of electric shock.

WARNING: To reduce the risk of electric shock, do not remove cover (or back) as there are no user-serviceable parts inside. Refer servicing to qualified personnel.

- The exclamation point within an equilateral triangle is intended to alert the user to the presence of important operating and maintenance instructions in the literature accompanying the appliance.
- No naked flame sources, such as lighted candles, should not be placed on the apparatus.
- Do not use this product near water or moisture.
- Clean only with a dry cloth.
- Unplug this product from the wall outlet before cleaning.
- Place the unit on a solid surface.
- Do not put it in a closed bookcase or a cabinet that may keep air from flowing through its ventilation openings.
- Do not install near any heat sources, such as radiators, heat registers, stoves or other appliances that produce heat.
- Protect the power cord from being walked on or pinched, particularly at plugs and the point where they exit from the product.
- Servicing is required when the product has been damaged. Do not attempt to service this product yourself. Opening or removing covers may expose you to dangerous voltages or other hazards. Please contact the manufacturer to be referred to an authorized service center near you.
- To prevent risk of fire or electric shock, avoid over loading wall outlets, extension cords, or integral convenience receptacles.
- Do not let objects or liquids enter the product.
- Use proper power sources. Plug the product into a proper power source, as described in the operating instructions or as marked on the product.

Table of Contents

Safety instructions	2
Table of Contents	3
Features	4
Carton contents	4
Controls, connectors and display	5
Getting started	6
Preset stations	7
Recall stations	7
Charging the battery	7
DAB radio mode	8
Selecting stations	8
Full scan	8
Manual tune	8
DRC (Dynamic range compression)	8
Prune	8
FM radio mode	9
Selecting stations	9
Scan settings	9
Audio settings	9
System	10
Sleep	10
Alarm and Snooze	10
Time	10
Language	11
Factory Reset	11
SW Version	11
Technical specifications:	12

Features

DAB/DAB+ digital radio with a wide choice of channels and digital quality sound broadcast free-to-air

FM with RDS (Radio Data System)

Carton contents

Carefully remove your radio from the packaging. You can keep the packaging for later use:

- 1x ***Pinell Supersound MICRO*** unit
- 1x USB cable
- Quick start guide (printed on the packaging)

Controls, connectors and display

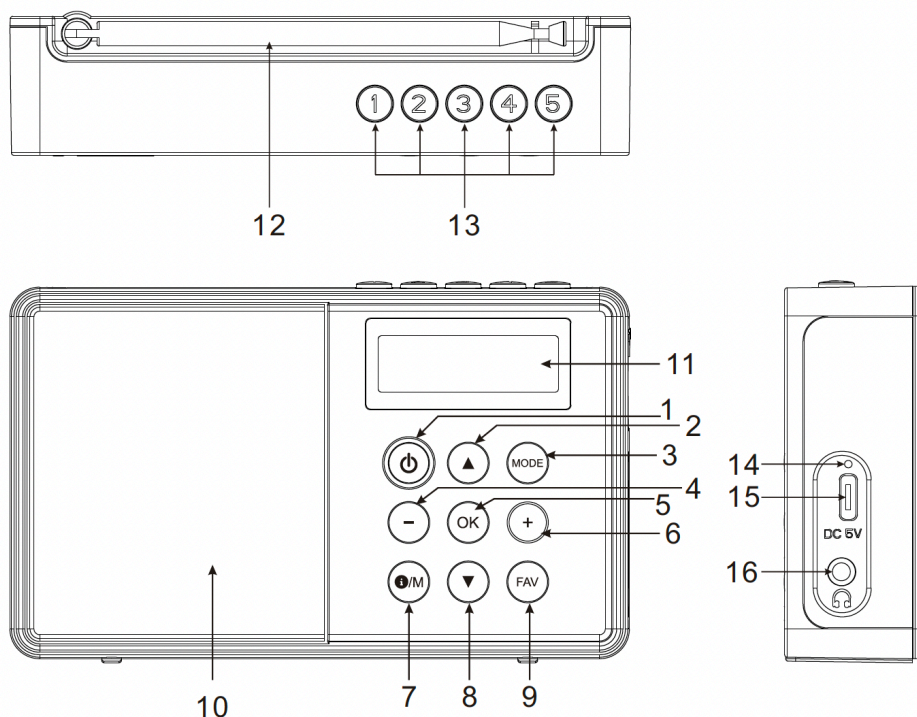

- 1 Press and hold to power on, press it briefly to power off.
- 2 **DAB**
 - Enter the station list after scan
 - Scroll up on the menu list**FM**
 - Every press of the button will scan the frequency downward by 0.05MHz
 - Press and hold the button for 2 seconds, the radio screen will display 'Scanning', it stops to scan until it reaches next upward available station, and starts to play
 - Scroll up on the menu list
- 3 **MODE** When the radio is powered on, press to switch between the radio modes
- 4 - Press to reduce the volume level
- 5 **OK**
 - Press to confirm selections made
 - Press and hold the button in FM mode to initiate an auto scan. The stations received are saved into preset station list automatically
 - Under FM, press the OK button to switch Mono or Stereo when the screen stays in FM playing mode
- 6 **+** Press to increase the volume level

- 7 **i / M**
- Long press to enter DAB / FM menu option
 - Repeated short press to cycle through additional information broadcasted on DAB / FM, including info about battery power remaining
- 8 **▼**
- DAB**
- Enter the station list after scan
 - Scroll down on the menu list
- FM**
- Every press of the button will scan the frequency downward by 0.05MHz
 - Press and hold the button for 2 seconds, the radio screen will display 'Scanning', it stops to scan until it reaches next upward available station, and starts to play
 - Scroll down on the menu list
- 9 **FAV**
- Press and hold the button to store a preset
 - Press briefly to enter the recall a station
- 10 **Speaker**
- 11 **Display**
- 12 **Antenna**
- 13 **PRESET button 1-5**
- Press and hold to store a preset
 - Press briefly to recall a station
- 14 **LED indicator for battery charging**
- 15 **USB port for charging internal battery**
- 16 **Earphone socket**

Getting started

Supersound MICRO is easy to use. To play DAB or FM radio, all you need is a power source (built-in rechargeable battery or USB power).

Quick setup

Fully extend the Telescopic antenna to ensure good reception in both DAB and FM Radio modes. It may be necessary to alter the position of the DAB Digital Radio and/or the Telescopic antenna to achieve the best signal.

1. Connect the USB cable to the input in the side of the **Supersound MICRO** and then plug the cable into an USB powers supply.
2. Fully extend the rear telescoping antenna.
3. Press the  button to turn the **Supersound MICRO** on.
4. Press the **MODE** button to select the desired source.

Turn ON / OFF or set to Standby

Battery-mode:

Press  to power the **Supersound MICRO** On (long press) or Off (short press).

USB-mode:

Press  to power the **Supersound MICRO** On (short press), Standby (short press) or Off (long press).

Note: Unplug the USB power to turn off your **Supersound MICRO** completely.

MODE: Press repeatedly to cycle through the sources: DAB, FM.

Preset stations

You can store up to 20 DAB presets and 20 FM presets.

Position 1 - 5 via PRESET button:

Long press one **PRESET** button, until „Preset x stored” appears

Position 1 - 20 via menu:

Short press **FAV** > ▲/▼ select position > **OK**

Recall stations

Position 1 - 5 via PRESET buttons:

Short press **PRESET**

Position 1 - 20 via menu:

Short press **FAV** > ▲/▼ select position > **OK**

Charging the battery

You can check the remaining battery power on the radio.

Press  / **M** repeatedly until you see the following indication:

ABC dig
Battery 74 ← percentage of remaining battery power

The message "Battery Low" is displayed to remind you to recharge the battery.

To charge the battery, connect the USB-C connector to the port on the side of the radio and connect the other end to a power source supplied with 5.0 V OUT. The LED will turn red when the battery is charging.

If the radio is off during charging, the LED will turn off when charging is complete. If the radio is on during charging, the LED will remain red even when charging is complete. Please check the battery indicator to see the status of charging.

DAB radio mode

DAB radio mode receives DAB/DAB+ digital radio and displays information about the station, stream and track playing.

The menu options are: Full scan, Manual tune, DRC, Prune, System.

Selecting stations

To listen to or change a station, press **▲/▼** > **OK** to select. Once selected, the station plays and the screen shows information about the station.

Full scan

Long press **i** / **M** > **▲/▼** > Full scan > **OK** to confirm. Full scan starts automatically. Once a scan is completed, the radio returns to play the previously selected station or first station on the station list.

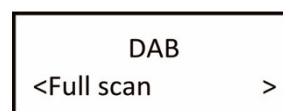

Note: If no radio station found, it shows “No DAB station” or “Service not available”. For a better reception, extend the antenna or do the full scan again in another place.

Manual tune

This can help you when adjusting your antenna or when adding stations that were missed while auto tuning.

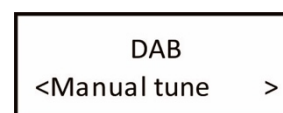

Long press **i** / **M** > **▲/▼** > Manual tune > **OK** to confirm > **▲/▼** to select a particular channel/frequency > **OK** to confirm. The display shows a live indication of the received signal strength on the selected frequency.

DRC (Dynamic range compression)

DRC reduces the difference between the loudest and quietest audio being broadcast. Effectively, this makes quiet sounds comparatively louder and loud sounds comparatively quieter. Options: high / low / off

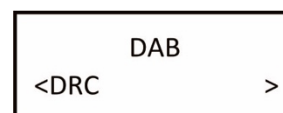

Long press **i** / **M** > **▲/▼** > DRC > **OK** to confirm > **▲/▼** to select option > **OK** to confirm.

Note: DRC only works if it is enabled by the broadcaster for a specific station.

Prune

You may remove all unavailable stations from the station list.

Long press **i** / **M** > **▲/▼** > Prune > **OK** to confirm > **▲/▼** to select “Yes” or “No” > **OK** to confirm.

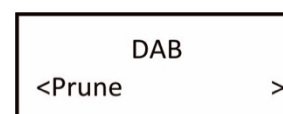

FM radio mode

FM radio mode receives analogue radio from the FM band and displays RDS (Radio Data System) information about the station.

The menu options are: Scan setting, Audio setting and System.

Selecting stations

To find a station, press and hold ▲/▼. The frequency display starts to run as **Supersound MICRO** scans the FM band.

Scan settings

This enables you set FM scans to stop at stations with strong signal or stop at any available station.

Options: Strong stations / All stations

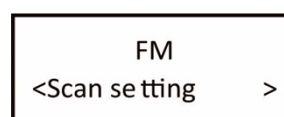

Long press **i** / **M** > ▲/▼ > Scan setting > **OK** to confirm > ▲/▼ to select “Strong stations” or “All stations” > **OK** to confirm.

Audio settings

By default, all stereo stations are reproduced in stereo. For weak stations, this may result in poor quality audio. The audio quality can be improved using mono.

Options: Stereo allowed / Forced mono

Long press **i** / **M** > ▲/▼ > Audio setting > **OK** to confirm > ▲/▼ to select “Forced mono” or “Stereo allowed” > **OK** to confirm.

System

The System menu options are: Alarms, SW version, Factory Reset, Language, Time, Sleep.

Sleep

When listening to the radio you can set a period of time before the radio enters “standby” mode (or gets powered off in battery mode).

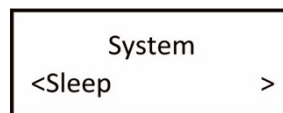

Note: the radio must be active and not in “standby” mode already.

Long press **i** / **M** > ▲/▼ > System > **OK** > ▲/▼ > Sleep > **OK** to confirm > ▲/▼ > select “15 / 30 / 45 / 60 / 90 minutes or Sleep off” > **OK** to confirm.

Alarm and Snooze

Your radio includes dual alarms.

Long press **i** / **M** > ▲/▼ > System > **OK** > ▲/▼ > Alarms > **OK** > select Alarm 1 or Alarm 2 > **OK** > configure the following parameters:

- **Select**: On or Off
- **On time**: 00:00 (adjust as necessary)
- **Source**: Buzzer, DAB or FM
- **Enable**: Once, Workday, Weekdays or Daily
- **Alarm volume**: use ▲/▼ to set the desired sound level

Press **OK** to set the Alarm.

Press any button (Except **⏻**) to snooze (5 min) or press **⏻** to cancel the alarm.

Note: Alarm and Snooze functions are only available with USB power connected.

Time

If there is any DAB+ radio signal, **Supersound MICRO** will automatically update the time.

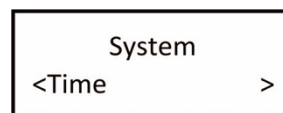

Long press **i** / **M** > ▲/▼ > System > ▲/▼ > Time > **OK** to confirm.

- Set Time/Date: set hour / minute / day / month / year > saved
- Auto update options: Update from Any / Update from DAB / Update from FM / No update
- Set 12/24 hour: 12 hours/24 hours

Language

This feature enables you to change menu language.

Long press **i**/ **M** > ▲/▼ > System > **OK** > ▲/▼ > Language > **OK** > select your language > **OK** to confirm.

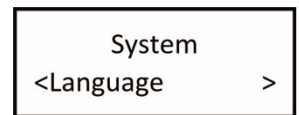

Factory Reset

This function clears all user defined settings, replacing them with the original default values, so time/date, preferences/settings, station list and preset stations are all lost.

Long press **i**/ **M** > ▲/▼ > System > **OK** > ▲/▼ > Factory reset > **OK** > select "Yes" > **OK** to start the factory reset.

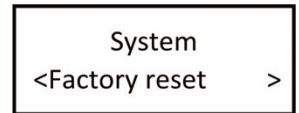

SW Version

This is used to display the current software version.

Long press **i**/ **M** > ▲/▼ > System > **OK** > ▲/▼ > SW version > **OK** to display current SW version

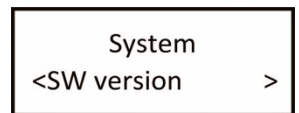

Technical specifications:

Model: ***Pinell Supersound MICRO***

Type: Portable Radio

Speaker: full range driver

Power: 1W RMS

Power Supply: USB power or built-in rechargeable battery

Dimension (mm): W 126 x D 27 x H 76

Weight: 0,17 kg



This symbol on the product or in the instructions means that your electrical and electronic equipment should be disposed at the end of its life separately from your household waste. For more information, please contact the local authority or your retailer where you purchased the product.



The product is CE certified. The manufacturer assures that this product will only be placed on the market in conformity with the LVD, EMC, RED and RoHS directives. The declaration of conformity can be found here: www.pinell.com/certificates

* Information in this manual is subject to change without notice.

Pinell is a label of TT Micro AS (www.ttmicro.no)
Olav Helsets vei 5, 0694 Oslo, Norway (Email: Support@pinell.no)