



User Manual

SUPERSOUND 301

DAB/DAB+ / FM / Internet Radio / Bluetooth / Spotify

Important Safety Instructions

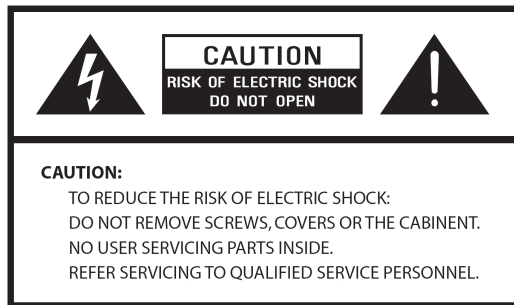

- Read these instructions
- Keep these Instructions
- Heed all Warnings
- Follow all instructions
- Do not use the speaker near water
- Clean only with dry cloth

WARNING: DO NOT EXPOSE THIS SPEAKER TO RAIN OR MOISTURE.

1. Do not place unit near any heat source such as radiators, heat registers, stoves, or other apparatus that produce heat.
2. Do not attempt to use unit in temperatures outside the range of 0°C~40°C.
3. Do not block any ventilation openings of unit.
4. The unit shall not be exposed to dripping or splashing. No objects filled with liquids, such as vases, shall be placed on the unit.
5. Do not place any heavy loads onto the unit, and do not step on it.
6. Please read Rating Labels at the rear of unit for power input and other safety information.
7. This unit is intended to be used only with the power supply provided.
8. Protect the power cord from being walked on or pinched particularly at the plugs, convenience receptacles, and at any point where they exit from the unit.
9. Never unplug your unit by pulling on the power cord. Always grasp the plug firmly and pull straight out from the outlet.
10. Replace all electric service cords that have become frayed or otherwise damaged immediately. Do not use a cord that shows cracks or abrasion damage.
11. Unplug the unit for additional protection during thunderstorms or when the unit is not used for prolonged periods.
12. Any service work should be carried out by qualified technicians only.
13. The cabinet may only be opened by qualified technicians.
14. The normal function of the product may be disturbed by strong Electro-Magnetic Interference. If so, relocate the source of disturbance. Reset the product to resume normal operation.
15. The means of disconnecting this apparatus from the mains supply is plug of adapter. The disconnect device shall remain readily operable.
16. In the interests of safety and to avoid unnecessary energy consumption, never leave the unit switched on while unattended for long periods of time, e.g. overnight, while on holiday or while out of the house. Switch it off and disconnect the mains plug from the mains socket.

Table of Contents

Important Safety Instructions.....	2
Table of Contents.....	3
Your radio	5
Front View	5
Rear View	5
Remote Control View (1 st Generation).....	6
Remote Control View (2 nd Generation).....	7
Getting Started.....	8
Setup Wizard	9
DAB+ Mode	11
Selecting DAB+ Mode.....	11
Selecting another Station	11
Scanning Stations.....	11
Manual Tune.....	11
Prune Invalid.....	12
DRC (Dynamic Range Control) value	12
Changing Station Order	12
Viewing Station Information.....	13
Storing Preset Stations	13
Recalling a Preset Station.....	13
FM Mode	14
Selecting FM Mode.....	14
Scan settings.....	14
Audio Settings.....	14
Viewing Station Information.....	15
Storing Preset Stations	15
Recalling a Preset Station.....	15
Internet Radio Mode	16
Local “Country”	16
Selecting a station through “Stations”.....	17
Selecting a program through “Podcasts”.....	18
Storing Preset Stations	18
Recalling a Preset Station.....	19
Register for Online Favourites.....	19
Adding station to “My Favourites”.....	19
View Station Information (via Remote Control)	19
Spotify Connect Mode.....	20
Spotify Premium	20
Play Music via Spotify Connect	20
Controlling Spotify Connect.....	21
Using another Spotify account with your radio	21
Bluetooth Mode.....	22
Aux in Mode.....	22

Music Player Mode	23
Sharing Media with Windows Media Player	23
Playing Shared Media	24
My Playlist	24
Repeat Play Mode	25
Shuffle Play Mode	25
Clearing My Playlist	25
Now Playing Information	25
Wireless Control App - UNDOK	26
General Operation	28
Setting Sleep	28
Setting Alarm	28
Setting Equaliser	29
Network Setup	29
Setting Time/Date	30
Setting Language	30
Factory Reset	30
Software Update – Over the network	31
Setup Wizard	31
Viewing System Info	31
Setting Backlight	32
Multiroom (not all models)	33
Troubleshooting	36
Specifications	37

Your radio

Front View

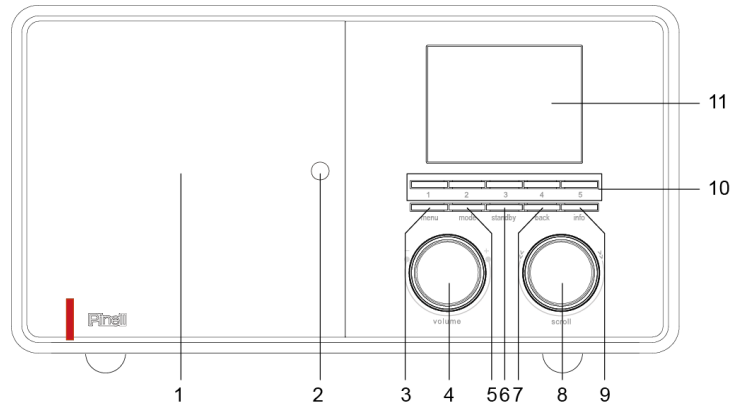

1. **Speaker**
2. **Remote control sensor**
3. **MENU** button
Press to display or exit menu screen.
4. **VOLUME** knob
Turn to adjust volume level.
5. **MODE** button
Press to switch among Internet, Spotify, Music Player, DAB, FM, Aux in and Bluetooth mode.
6. **STANDBY** button
Press to turn on the radio or switch to standby mode.
7. **BACK** button
Press to return to previous menu screen.
8. **SCROLL** knob
Turn to browse options.
Press to confirm selection.
9. **INFO** button
Press to activate snooze function when alarm sounds.
Press to browse station information.
10. **PRESET 1-5** buttons
Press and hold to directly save station.
Press to directly play saved station.
11. **Display**

Rear View

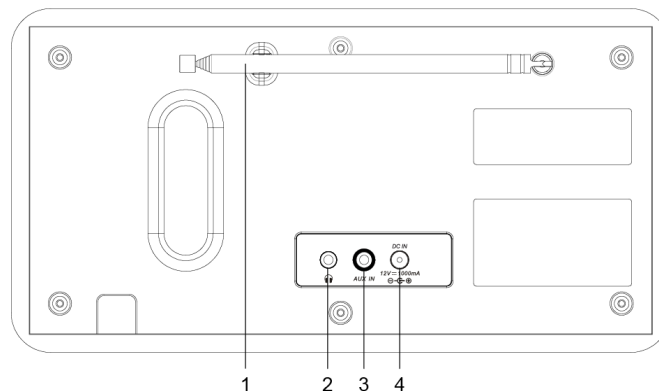

1. **DAB/FM antenna**
2. **Headphones 3.5mm socket**
3. **AUX IN 3.5mm socket**
4. **DC IN socket**

Remote Control View (1st Generation)

1. **STANDBY/ON** button
Press to switch radio on or standby
2. **BACKLIGHT** button
Press to set backlight
3. **MODE (FUNCTION)** buttons
Press to switch among Internet, Spotify, Music Player, DAB, FM, Aux in and Bluetooth modes.
4. **EQ** button
Press to set EQ.
5. **VOLUME +/-** buttons
Press to adjust volume level
6. **MUTE** button
Press to mute radio or resume sound.
7. **⏮** button (Music Player and Bluetooth mode)
Press to skip to previous track; press and hold to fast reverse current track
8. **⏭** button (Music Player and Bluetooth mode)
Press to skip to next track; press and hold to fast forwards current track
9. **SELECT** button
Press to confirm selection
< ^ v > buttons
Press to browse options
10. **MENU** button
Press to display or exit menu screen.
11. **⏸/⏪** button (Music Player and Bluetooth mode)
Press to pause or play current track
12. **SLEEP** button
Press to set up sleep time
13. **SNOOZE** button
Press to activate snooze function when alarm sounds
14. **ALARM** buttons
Press to set alarm 1 or alarm 2
15. **SCAN** button
Press to automatically scan for available stations in DAB and FM mode
16. **INFO** button
Press to view station information
17. **CLOCK ADJ** button
Press to set clock
18. **1-10** buttons
Press and hold to save preset stations
Press to recall a saved preset station

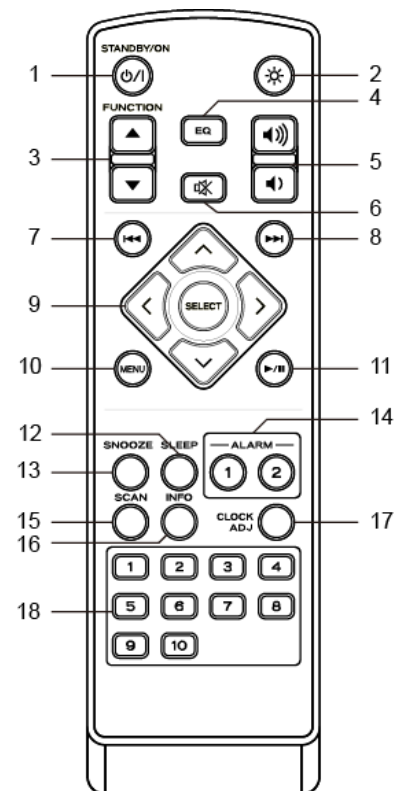

Remote Control View (2nd Generation)

1. **STB** button
Press - switch on the radio or put it to standby
2. **SRC** button
Press - switch between DAB, FM, Internet Radio, Spotify, Music Player, Aux In and Bluetooth
3. **ALARM** button
Press - set Alarm 1 and/or 2
4. **SLEEP / SNOOZE** button
Press SLEEP – set sleep time
Press SNOOZE - activate snooze when alarm goes on
5. **PRG / SHUF / REP** button (Supersound 701)
6. **INFO** button
Press - show station information step by step
7. **⏸** button (Music Player and Bluetooth)
Press - pause/play title
8. **🔊** button (Supersound 701)
9. **🔊+ / 🔊-** **VOLUME +/-** button
Press - change volume
10. **⏮ / ⏭** button (Music Player and Bluetooth)
Press - previous/next title
Press & hold - fast forward/backward
11. **SELECT** button
Press - select
< ^ v > button
Press – select option
12. **OK / MUTE** button
Press - select/confirm
Press - mute on/off
13. **MENU** button
Press - display or close menu
14. **BACK** button
Press - back to previous menu
15. **1-10, 10+, P** button
Press & hold - store station
Press - recall station
10+ button
Press 10+ and 1-10 for position 11-20
P button
Press - display list

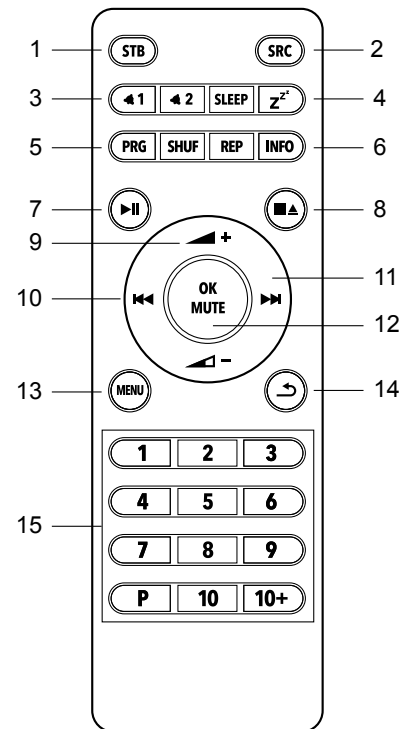

Getting Started

Carefully remove your radio from the box. You may wish to store the packaging for future use.

What you can find inside of your package

- 1x Main unit Supersound 301
- 1x Power adapter
- 1x Remote control and 2x AAA alkaline battery
- 1x Quick start guide

Positioning your Radio

Place your radio on a flat / stable surface that is not subject to vibrations.

Avoid the following locations:

- Where the unit will be exposed to direct sunlight.
- Where the unit will be close to heat radiating sources.
- Where the humidity is high and ventilation is poor.
- Where it is dusty.
- Where it is damp or there is a possibility of water dripping or splashing onto unit.

Adjusting the Antenna

Fully extend antenna to ensure you receive the best reception possible in both DAB and FM radio modes. It may be necessary to adjust the position of the radio and/or antenna to achieve the best signal.

Turning the Unit On/Off

Connect the plug at the end of power adapter cable to the **DC IN** socket on the rear of unit. Then insert the power adapter into the mains socket. The radio will go to standby.

Press **STANDBY** button to turn on the radio. To turn off unit completely, unplug the power adapter from the mains socket.

Replacing batteries:

1. Open the battery compartment cover at the back of your remote control.
2. Install 2pcs new AAA size batteries, referring to the marking direction inside the battery compartment.
 **Note:** do not reverse any battery and do not mix battery types, also do not mix old and new batteries. When discard your old battery, please considering eco-friendly.
3. Re-insert the battery compartment cover.

Setup Wizard

1. For initial use, radio will ask you to choose the language:
Turn **SCROLL** - select language - push **SCROLL**
2. The "Setup wizard" screen will appear.



3. Press **SCROLL** knob to confirm "YES" to start setup. Options include the following:

Date/Time

Set 12 or 24 hour format

Auto update

Synchronously update clock from the mode you select or set by manually.

- Update from DAB
- Update from FM
- Update from Network
- No update - Set date and time manually.

Keep network connected

Keeps network connected especially in non-internet mode (i.e. DAB, FM, Bluetooth and Aux in mode) to enable you can use Spotify all the time.

Select YES or NO

4. The Wizard will now scan your location for accessible wireless networks. When the scan has finished, a list of networks will be displayed.

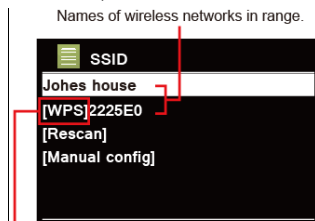

WPS security is available for this network.

Devices that support connection via WPS (Wi-Fi Protected Setup) are identified in the list as **[WPS]**.

5. Turn **SCROLL** knob and then press it to select your wireless network.
 - 1) If a WEP/WPA key (password) is required, radio will ask you to input the WEP/WPA code and display the password entry screen as follows:

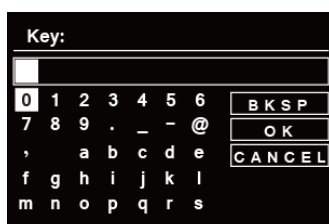

 **Note:** If a password (WEP/WPA) isn't required by your network, radio will connect to the network automatically.

a. Turn **SCROLL** knob to cycle through the alphanumeric character list, press **SCROLL** knob to select an appointed character.

 **Note:** WEP/WPA pass codes are case-sensitive.

b. If a wrong operation is being conducted, select **BKSP** to delete designated character.

 **Note:** **BKSP** = Backspace; **CANCEL** means return to previous track; radio will automatically save the WEP/WPA you've input, so no bother to re-enter these codes.

c. After selecting the final character of your password, turn **SCROLL** knob to **OK**, and then press **SCROLL** knob to confirm. The radio is connected to your wireless network.

2) If you wish to establish a connection via WPS, press **SCROLL** knob after you have selected desired network. The radio then offers the option to initiate WPS.

Turn **SCROLL** knob to select between Push Button, Pin and Skip WPS, press **SCROLL** knob to confirm.

Push Button	<p>You must start the WPS scan on the remote station (e.g. router). Consult the manual for your router or Access Points (AP) to learn how to do this.</p> <p>After you have done this, press SCROLL knob on the radio and then both devices will establish a connection.</p>
Pin	<p>The radio creates an 8-digit number, which you then have to enter into the remote station.</p> <p>After entering the PIN, press the SCROLL knob to establish the connection between both devices.</p>
Skip WPS	<p>In addition to a WPS connection, you can also establish a connection using a Pre-Shared-Key. The required key is often on the rear of the router, or you may have defined it yourself.</p> <p>This method is used automatically for networks without WPS. You can call up the Pre-Shared-Key function on networks with WPS by selecting menu item "Skip WPS".</p> <p>An input field should now appear. You can enter the required key (PSK) by turning SCROLL knob and then pressing SCROLL knob. Select "OK" and press SCROLL knob to complete the entry.</p> <p>The radio should now establish the connection to the network.</p>

6. Press **SCROLL** knob. The radio will run a full DAB+ scan. Turn **SCROLL** knob to select a station and press **SCROLL**. Setup is completed.

DAB+ Mode

Selecting DAB+ Mode

1. Press **MODE** button repeatedly to select DAB mode.
2. For initial use, radio will carry out a full scan and store stations list in memory

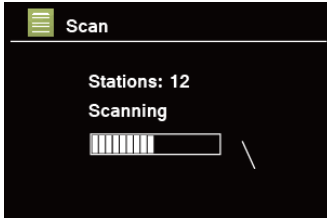

3. Once the scanning is completed, the DAB+ stations will be displayed in alphanumeric order. Turn **SCROLL** knob to select you desired station and then press **SCROLL** knob to broadcast.

 **Note:** if no DAB+ signal is found in your area, it may be necessary to relocate your radio to a stronger signal area.

Selecting another Station

1. While a program is playing, press **MENU** button, turn **SCROLL** knob to select “Station list”, and then press **SCROLL** knob to confirm.
2. Turn **SCROLL** knob to select the station you want to play, and then press **SCROLL** knob to confirm.

 **Note:** alternatively, turn **SCROLL** knob to cycle through station list and press **SCROLL** knob to confirm.

Scanning Stations

Press **MENU** button, turn **SCROLL** knob to select “Scan”, and then press **SCROLL** knob to run full scan.

Manual Tune

This can help you when adjusting your antenna or when adding stations that were missed while auto tuning.

1. Press **MENU** button, turn **SCROLL** knob to select “Manual tune”, and then press **SCROLL** knob to confirm, the display will show the channel number and frequency.
2. Turn **SCROLL** knob to select the channel you wanted, and then press **SCROLL** knob to confirm.

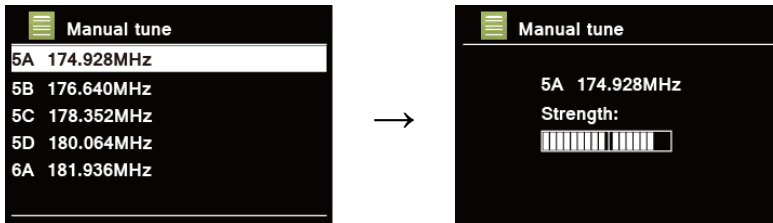

 **Note:** If there is a multiplex corresponding to channel and frequency, the display will show signal strength and multiplex name after a few seconds. The new station will be added to station list.

3. To play the station, first press **BACK** button repeatedly to exit manual tune.

Prune Invalid

You may remove all unavailable stations from the station list.

1. Press **MENU** button, turn **SCROLL** knob to select “Prune invalid”, and then press **SCROLL** knob to confirm.
2. Turn **SCROLL** knob to select “YES”, and then press **SCROLL** knob to confirm removing all invalid stations.

DRC (Dynamic Range Control) value

If you are listening to music with high dynamic range in a noisy environment (for example classical music while cooking), you may wish to compress the audio dynamic range. This makes quiet sounds louder and loud sounds quieter.

1. Press **MENU** button, turn **SCROLL** knob to select “DRC”, and then press **SCROLL** knob to confirm.
2. Turn **SCROLL** knob to select “DRC high”, “DRC low” or “DRC off”, and then press **SCROLL** knob to confirm.

Changing Station Order

You may want to display the stations in different order.

1. Press **MENU** button, turn **SCROLL** knob to select “Station order”, and then press **SCROLL** knob to confirm.
2. Turn **SCROLL** knob to select “Alphanumeric”, “Ensemble” or “Valid”, and then press **SCROLL** knob to confirm your selecting option.

Alphanumeric	Display all stations in alphanumeric order.
Ensemble	List currently broadcasting active stations before inactive ones.
Valid	Remove inactive stations from the station list.

Viewing Station Information

DAB/DAB+ stations broadcast additional information. Press **INFO** button repeatedly while a program is playing to view information through DLS (Dynamic Label Segment), Ensemble, Program Frequency, Signal Quality, Signal Strength, Bitrate, Codec, Channel and Date.

 **Note:** to view station information while the display is playing slide show in full screen, press **SCROLL** knob to play slide show in small image, and then you can press **INFO** button repeatedly to view information. Press **SCROLL** knob a second time to play slide show in full screen again.

Showing Signal Strength

While you selected signal strength, a signal bar with the strength of the current station will show on the display.

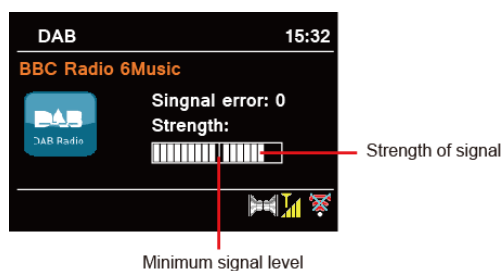

The indicator on the signal bar shows the minimum acceptable signal level.

 **Note:** Stations with signal strength below the minimum signal level may not provide a steady stream of audio.

Storing Preset Stations

You can store up to 5 of your favourite DAB/DAB+ stations via preset buttons at the front. This will enable you to access your favourite stations quickly and easily.

1. While playing your favourite station, press and hold one of **PRESET** buttons **1-5** until display shows "Preset stored".
2. Preset number "★ #" (# = 1-5) will show on the display.

 **Note:** Up to 20 favourites can be stored with the remote control.

2nd Generation remote control: For preset positions 11-20, first press 10+ and then hold down one of the PRESET buttons 1-10 until "Preset stored" appears on the display

Recalling a Preset Station

1. Press one of **PRESET** buttons **1-5** to play the saved preset station.
2. The display will show "Preset empty" if the preset position isn't allocated.

FM Mode

Selecting FM Mode

1. Press **MODE** button repeatedly to select FM mode.
2. For initial use, it will start at the beginning of the FM frequency range (87.50MHz). Otherwise, the last listened FM station will be selected.



3. **To manually scan**, while FM frequency shows up, turn **SCROLL** knob clockwise or anti-clockwise to change frequency by 0.05MHz per step.
4. **To automatically scan**, while FM frequency shows up, press **SCROLL** knob and your radio will automatically search until it reached the next available station.

Scan settings

This enables you set FM scans stop at stations with strong signal or stop at any available station.

1. Press **MENU** button, turn **SCROLL** knob to select "Scan setting", and then press **SCROLL** knob to confirm.
2. Display will show "Strong stations only?", turn **SCROLL** knob to select "YES", and then press **SCROLL** knob to confirm. The scans stop only at stations with good signal strength.
3. Turn **SCROLL** knob to select "NO", and then press **SCROLL** knob to confirm. The scans stop at any available station. This may result in a poor quality audio from weak stations.

Audio Settings

By default, all stereo stations are reproduced in stereo. For weak stations, this may result in a poor quality audio. The audio quality can be improved using mono.

1. To play weak stations in mono, press **MENU** button, turn **SCROLL** knob to select "Audio setting", and then press **SCROLL** knob to confirm.
2. Display will show "Listen in Mono only?", turn **SCROLL** knob to select "YES", and then press **SCROLL** knob to confirm.

Viewing Station Information

There is a variety of station information transmitted by broadcaster. To view currently playing station information, press **INFO** button repeatedly the display will show the information through Radio text, Program Type, Program Name and Date.

Storing Preset Stations

You can store up to 5 of your favourite FM stations via preset buttons at the front. This will enable you to access your favourite stations quickly and easily.

1. While playing your favourite station, press and hold one of **PRESET** buttons **1-5** until display shows "Preset stored".
2. Preset number "★#" will show on the display.

 **Note:** Up to 20 favourites can be stored with the remote control.

2nd Generation remote control: For preset positions 11-20, first press 10+ and then hold down one of the PRESET buttons 1-10 until "Preset stored" appears on the display

Recalling a Preset Station

1. Press one of **PRESET** buttons **1-5** to play the saved preset station.
2. The display will show "Preset Empty" if the preset station isn't allocated.

Internet Radio Mode

1. Press **MODE** button repeatedly to select Internet Radio mode.
2. While “Station list” is highlighted, press **SCROLL** knob to confirm.



3. Then refer following section to choose stations. Or if failed to connect to network, please follow:
 - a. Check your Router, see it working normally or not;
 - b. Relocate your radio to a stronger signal position is necessary.
 - c. Make sure your password is correct input.

Local “Country”

Local “Country” will change according to your current location (e.g. Local Norway). It displays local stations of your current location.

1. To enter local stations, press **MENU** button - **Station list** - **Local “Country”**, press **SCROLL** knob to confirm.



2. Station genres are listed. Turn **SCROLL** knob to select the genre you wanted, and then press **SCROLL** knob to confirm.
3. Turn **SCROLL** knob to select you desired station, and then press **SCROLL** knob to confirm broadcasting.

Selecting a station through “Stations”

Stations enables you to select a station from categories: Location, Genre, Popular stations or New stations, or search stations.

1. Press **MENU** button - **Station list - Stations**, press **SCROLL** knob to confirm.

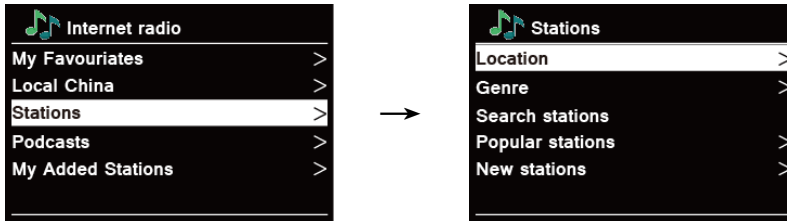

2. In “Stations” menu:

- “Location” enables you to choose from the radio stations provided by any country which you choose from a list.
 - a. While “Location” is highlighted, press **SCROLL** knob to confirm.
 - b. Turn **SCROLL** knob to select the region you wanted, and then press **SCROLL** knob to confirm.
 - c. Turn **SCROLL** knob to select the country you wanted, and then press **SCROLL** knob to confirm.
 - d. Turn **SCROLL** knob to select the station you wanted, and then press **SCROLL** knob to confirm. The station will be broadcast.
- “Genre” enables you to choose radio stations according to their content, for example Classic Rock, Sport, News, etc.
 - a. While “Genre” is highlighted, press **SCROLL** knob to confirm.
 - b. Turn **SCROLL** knob to select the genre you wanted, and then press **SCROLL** knob to confirm.
 - c. Turn **SCROLL** knob to select through All Stations, Highlighted Stations or the country you wanted, and then press **SCROLL** knob to confirm.
 - d. Turn **SCROLL** knob to select the station you wanted, and then press **SCROLL** knob to confirm. The station will be broadcast.
- “Search stations” enables you to enter all or part of station name to find a station.
- “Popular stations” enables your radio to list the stations that have the most listeners.
- “New stations” enables your radio to list the stations that have recently joined the Internet radio network.

 **Note:** Some radio stations do not broadcast 24 hours per day, and some stations are not always on-line.

Selecting a program through “Podcasts”

Podcasts enables you to select a podcast from categories: Location or Genre, or search podcasts.

1. Press **MENU** button - **Station list - Podcasts**, press **SCROLL** knob to confirm.

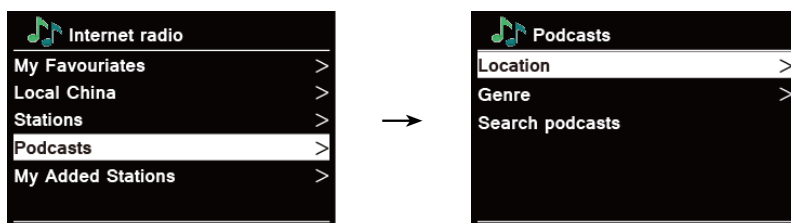

2. In “Podcasts” menu:

- “Location” enables you to choose from the podcasts provided by any country which you choose from a list.
 - a. While “Location” is highlighted, press **SCROLL** knob to confirm.
 - b. Turn **SCROLL** knob to select the region you wanted, and then press **SCROLL** knob to confirm.
 - c. Turn **SCROLL** knob to select the country you wanted, and then press **SCROLL** knob to confirm.
 - d. Turn **SCROLL** knob to select All Shows or By Genre, and then press **SCROLL** knob to confirm.
 - e. Turn **SCROLL** knob to select the podcast you wanted, and then press **SCROLL** knob to confirm. The podcast will be played.
- “Genre” enables you to choose radio stations according to their content, for example Classic Rock, Sport, News, etc.
 - a. While “Genre” is highlighted, press **SCROLL** knob to confirm.
 - b. Turn **SCROLL** knob to select the genre you wanted, and then press **SCROLL** knob to confirm.
 - c. Turn **SCROLL** knob to select the podcast you wanted, and then press **SCROLL** knob to confirm. The podcast will be played.
- “Search stations” enables you to enter all or part of podcast name to find a podcast.

Storing Preset Stations

You can store up to 5 of your favourite Internet Radion stations via preset buttons at the front. This will enable you to access your favourite stations quickly and easily.

1. While playing your favourite station, press and hold one of **PRESET** buttons **1-5** until display shows “Preset stored”.
2. Preset number “★ #” will show on the display.

 **Note:** Up to 20 favourites can be stored with the remote control.

2nd Generation remote control: For preset positions 11-20, first press 10+ and then hold down one of the **PRESET** buttons 1-10 until “Preset stored” appears on the display

Recalling a Preset Station

1. Press one of **PRESET** buttons **1-5** to play the saved preset station.
2. The display will show “Preset Empty” if the preset station isn’t allocated.

Register for Online Favourites

1. Press **MENU** button - **Station list** - **Help**, press **SCROLL** knob to confirm.
The Code is valid for 10 minutes
2. Access the Frontier-Nuvola Portal on your PC: <https://smartradio.frontier-nuvola.net>
Create account, enter the Code retrieved in 1. and register your radio.

Adding station to “My Favourites”

1. Search for station.

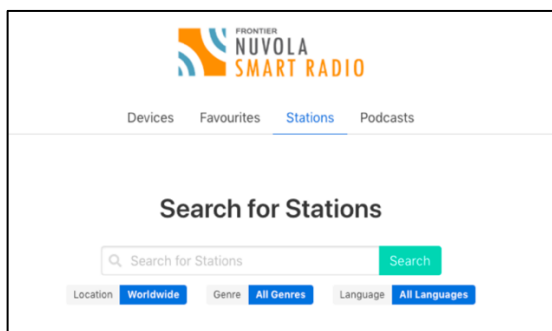

Click on the green heart to select the station.

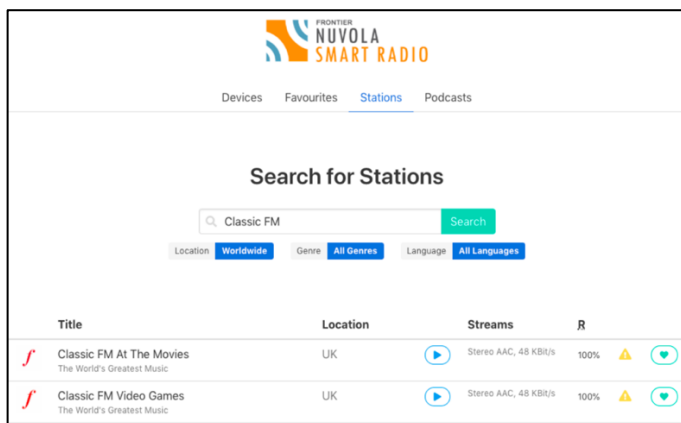

Select “Shared Favourites” in the next menu and click on “Save”.

2. The added stations are accessible by pressing **MENU** button - **Station list** - **My favourites**.
 **Note:** doing a “factory reset” cannot erase “my favourites stations”.

View Station Information (via Remote Control)

Internet programs send additional information. Press the **INFO** button repeatedly while a program is playing. The display will show information about station description, genre, country, reliability, bitrate, codec, sample rate, playback buffer, and date.

Spotify Connect Mode

Your radio has Spotify Connect built in. Spotify Connect lets you control the music playing on your device, using the Spotify app on your mobile, tablet or PC. Listening is seamless. You can take calls, play games, even switch your phone off – all without interrupting the music.

Learn more at spotify.com/connect

Spotify Premium

You'll need a Spotify Premium account to use Spotify Connect.

Spotify Premium lets you listen to millions of songs ad-free – the artists you love, the latest hits and discoveries just for you. Simply hit play to hear any song you like, at the highest sound quality.

Check out our current Premium offers at spotify.com/premium

Play Music via Spotify Connect

1. Download Spotify app for your smartphone or tablet (iOS or Android).
2. Add your speakers to your wifi network, and then press **MODE** button on your radio repeatedly to select **Spotify Connect** mode.
3. Fire up the Spotify app on your smartphone or tablet using the same wifi network as above.
4. Play a song on Spotify and hit “DEVICES AVAILABLE”.
5. Tap “Pinell Supersound 301” from the list and your music will start playing out loud.

If you can't see it, just check it's connected to the same network as your phone or tablet.

You will notice that your radio is currently listed as “Pinell Supersound 301 xxxxxxxxxxxx” (the 12 digit alphanumeric code is the MAC address of your radio) in the Spotify App.

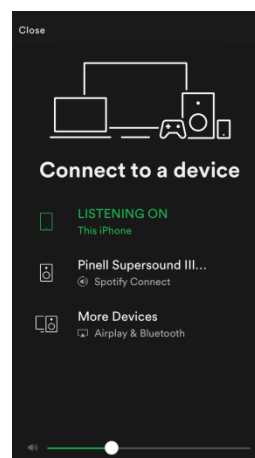

6. Your Spotify app will only recognize your radio when the radio is connected to the internet (i.e. in Internet Radio, Spotify Connect or Music Player mode). To use Spotify when your radio is in non-internet modes (i.e. in DAB, FM, Bluetooth or Aux in mode) you need to select **Main menu - System settings - Network - Keep network connected - YES**. This also allows you to wake the radio from standby using your Spotify app.

 **Note:** *If unattended to use radio for long periods of time, e.g. overnight, while on holiday or while out of the house, select “NO” to avoid unnecessary energy consumption.*

Controlling Spotify Connect

You can now control Spotify from the app like normal; search for and play your tracks, change the volume and add to playlists even though playback is through your radio. The next time you open the Spotify app, playback will continue through your radio.

Spotify Connect is a cloud-based service, therefore after activation on your radio, your smartphone or tablet no longer needs to be on the same network to control audio playback.

Using another Spotify account with your radio



Your Spotify account details are now stored on your radio. To overwrite this with another Spotify account, simply follow the activation steps again whilst running the Spotify app using your desired account. Please remember that both your smartphone or tablet and your radio need to be on the same network for the overwriting to occur.

Bluetooth Mode

Pair the unit with a Bluetooth device to listen to music:

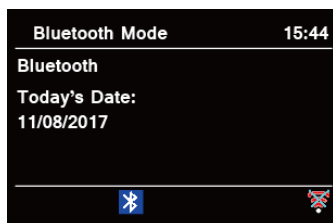
1. Press the **MODE** button to select Bluetooth mode.



2. The display will flash in  repeatedly.
3. Activate your Bluetooth device and look for your radio's model number "Pinell Supersound III" in the Bluetooth list.
4. Select "Pinell Supersound III" and enter "0000" for the password if necessary.
5. The  icon will remain steadily on the display when connection is successful.
6. To disconnect the Bluetooth connection, press **MENU** button, turn **SCROLL** knob to select "BT disconnect", and then press **SCROLL** knob to confirm. The display will show "Device disconnect?", turn **SCROLL** knob to select "YES", and then press **SCROLL** knob to confirm.

 **Note:** the unit will automatically switch to standby mode after 15 minutes if the source device is disconnected, switched off or the volume is too close to mute.

Aux in Mode

AUX IN allows for quick and easy connection to an MP3 player or other external audio sources.

1. Before connecting to the mains socket, use a 3.5mm audio cable (not supplied) to connect to your external audio device through the **AUX IN** socket at the rear of unit.
2. Connect power adapter to mains socket, press **STANDBY** button to switch unit on.
3. Press **MODE** button repeatedly to select AUX In mode.



4. In Aux in mode, you may operate your audio device directly for playback features.
5. To gain optimal volume levels, adjusting the output volume level on the audio device as well is recommended.

 **Note:** the unit will automatically switch to standby mode after 15 minutes if the source device is disconnected, switched off or the volume is too close to mute.

Music Player Mode

In order for your radio to play music files from a computer, the computer must be set up to share files or media.

The built-in Music Player allows devices like this radio to play unprotected audio files (AAC, MP3, WMA) from a shared media library, navigating through tag menus such as Artist, Album or Genre.

If you are running a suitable server system such as a PC with Windows Media Player10 or later (WMP), and your music library is well-tagged, then it is recommended to use media sharing. Only the UPnP (Universal Plug and Play) server needs to be set up. (iTunes does not currently work as a UPnP media server.)

Sharing Media with Windows Media Player

The most common UPnP server is Windows Media Player (10 or later. View version from **Help - About Windows Media Player**). Alternatively, other UPnP platforms and servers may be used.

To set up WMP for media sharing, perform the following steps:

1. Ensure that the PC is connected to the network.
2. Ensure that the radio is powered on and connected to the same network.
3. In WMP, add to the media library the audio files and folders you want to share with your radio by selecting **Organize - Manage Libraries - Music / Videos / Pictures / Recorded TV**, click "Add" to add audio files and folders and then click "OK" to finish adding.

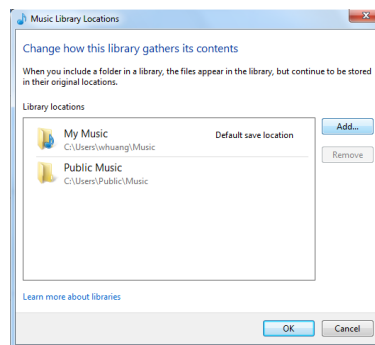
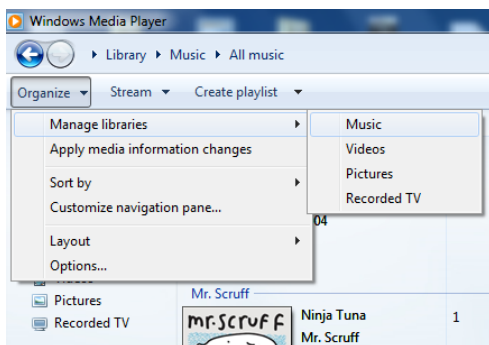

4. In WMP, enable media sharing (**Stream - More streaming options...**).

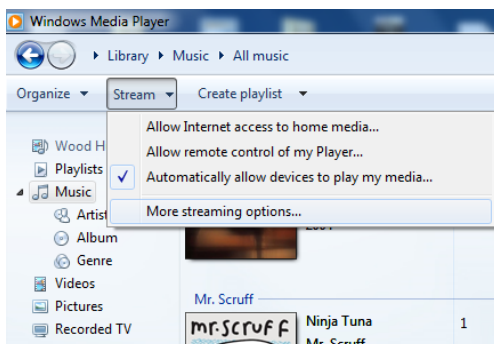

5. Make sure that the radio has access to the shared media by selecting it and clicking “Allow”. You can also set a name for the shared media in the box of “Name your media library”. Click “OK” to close the dialogue boxes.

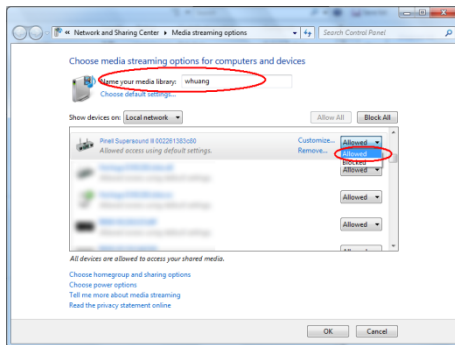

6. The PC is now ready to stream the music to the radio. The WMP UPnP service runs in the background; there is no need to start WMP explicitly.

Playing Shared Media

1. Press **MODE** button repeatedly to select Music Player mode.
2. While “Shared media” is highlighted, press **SCROLL** knob to confirm.

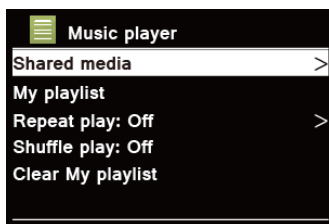

3. Available media servers will be listed. Turn **SCROLL** knob to select and press to confirm, and then step by step to your selecting music.



My Playlist

The My Playlist feature enables you to create a playlist of your favourite tracks from your music libraries.

Once you have your playlist ready you can choose to play through the playlist on your radio and can also set shuffle and repeat play functions while your playlist is playing.

1. To save a track to “My playlist”, browse the track you want to add to the playlist, press and hold **SCROLL** knob, and then the track is added to the playlist.
2. To play “My playlist”, press **MENU** button, and then turn **SCROLL** knob to select “My playlist”, press **SCROLL** knob to confirm. Browse the track you want to play, press **SCROLL** knob to select.

Repeat Play Mode

Press **MENU** button, and then turn **SCROLL** knob to select “Repeat play: Off”, then press **SCROLL** knob repeatedly to shift repeat play “On” or “Off”.

Shuffle Play Mode

Press **MENU** button, and then turn **SCROLL** knob to select “Shuffle play: Off”, then press **SCROLL** knob repeatedly to shift repeat play “On” or “Off”.

Clearing My Playlist

This feature enables you to clear the contents of your playlist.

1. Press **MENU** button, turn **SCROLL** knob to select “Clear My playlist”, and then press **SCROLL** knob to confirm.
2. Select “YES” to clear my playlist.

Now Playing Information

While a track is playing, the display shows the track and a progress bar with figures for elapsed and total track time.



To view further information, press **INFO** button repeatedly to show the information through Artist, Album, Bit Rate, Codec, Sampling Rate, Playback buffer and Date on the display.

Wireless Control App - UNDOK

UNDOK App enables you use your smartphone (or tablet) to wirelessly control your radio when both devices connecting to same network.

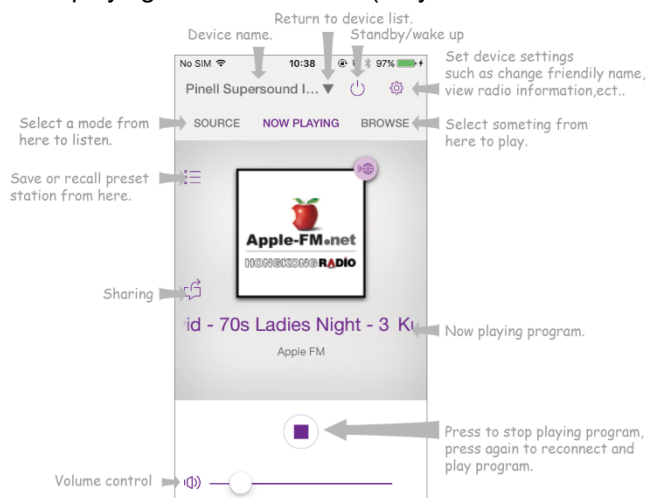
1. Download **UNDOK**  app from **App Store** (iOS) or **Google Play** (Android) on your smartphone or tablet.
2. Start UNDOK app, making sure your radio and smartphone are connected to same WiFi network.
3. All available devices will be listed. Tap your radio “Pinell Supersound 301 xxxxxxxxxxxx” (the 12 digit alphanumeric code is the MAC address of your radio) to connect to.
4. Now playing screen is shown. (Play Internet radio mode for example.)



5. To save a preset station, tap Preset  icon on now playing screen and then Presets screen will pop up. Tap the plus sign  after number 1-10 to save preset station. (Fig. 1)
6. To recall a preset station, tap the station name on the Presets screen to play the station. (Fig. 2)

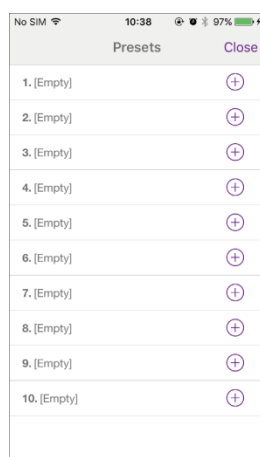

Fig. 1

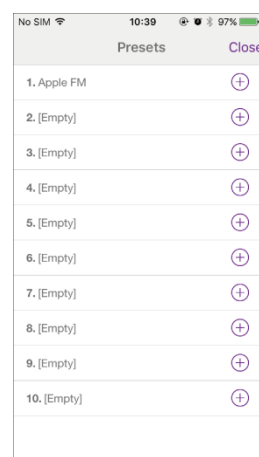



Fig. 2

7. To ensure your radio only can be controlled by definite smartphone, you can set a PIN code which you should input on UNDOK app to get authority to connect to your radio. The default code is 1234, you also can give a user-defined code from **Main menu - System settings - Network – NetRemote PIN setup**.

8. To ensure you can use UNDOK app in all modes especially in non-internet modes (i.e. in DAB, FM, Bluetooth or Aux in mode) you need to select **Main menu - System settings - Network - Keep network connected - YES**. This also allows you to wake the radio from standby by using your UNDOK app.

 **Note:** *If unattended to use radio for long periods of time, e.g. overnight, while on holiday or while out of the house, select "NO" to avoid unnecessary energy consumption.*

General Operation

Setting Sleep

This feature enables your radio to switch to standby mode by itself after a set sleep time.





1. Press **MENU** button - **Main menu** - **Sleep**, and then press **SCROLL** knob to confirm.
2. Turn **SCROLL** knob to select a sleep time, and then press **SCROLL** knob to confirm. The sleep icon  and sleep time will show on the display.
The sleep time options: Sleep OFF/15/30/45/60 MINS
3. To turn the sleep function off while the sleep timer is still counting down, select "Sleep" option, turn **SCROLL** knob to select "Sleep OFF".

Setting Alarm

Your radio includes dual alarms. Set Alarm, making sure set time at first.

1. Press **MENU** button - **Main menu** - **Alarms**, and then press **SCROLL** knob to confirm.
2. Turn **SCROLL** knob to select "Alarm 1" or "Alarm 2", and then press **SCROLL** knob to confirm.
3. Turn **SCROLL** knob to select options, and then press **SCROLL** knob to confirm the setting.

Enable	Alarm active day: Off, Daily, Once, Weekends or Weekdays
Time	Alarm time: 00:00 (manually set up the time)
Mode	Alarm mode: Buzz, Internet radio, DAB or FM (If the wake-up mode is DAB and the DAB+ signal strength is low, the buzzer alarm will be triggered.)
Preset	Last listened or saved preset station (not available for Buzz mode).
Volume	Alarm volume
Save	Save the alarm

4. When the display shows "Alarm Saved", the alarm setting is successful.  or  will show on the display.
5. **To temporarily switch off alarm**, press **SCROLL** knob repeatedly to set snooze time for 5, 10, 15 or 30 minutes in turn. The unit will go to standby and snooze time will show on the display.
6. **To turn off alarm**, press the **STANDBY** button when the alarm sounds.
7. **To cancel Alarm**, refer to steps 1-3 to enable alarm "Off".  or  will disappear from display

Setting Equaliser

This feature enables you to choose a sound equalization profile. Each of the equalization setting will change the tone of the sound from your radio when selected.

1. Press **MENU** button - **Main menu** - **System settings** - **Equaliser**, and then press **SCROLL** knob to confirm.
2. Turn **SCROLL** knob and then press it to select a profile. The equalization profile options: Normal/Flat/Jazz/Rock/Movie/Classic/Pop/News/My EQ.
3. To set up My EQ, select "My EQ", and then press **SCROLL** knob to confirm. Turn **SCROLL** knob to select "Bass" or "Treble", and then press **SCROLL** knob to confirm. Turn **SCROLL** knob to change the value of Bass or Treble, and then press **SCROLL** knob to confirm. Or select "Loudness" and then press **SCROLL** knob to set "On" or "Off". Press **BACK** button, display will show "Save changes". Turn and press **SCROLL** knob to select "YES" to save changes.

Network Setup

Users encountering networking issue may find these options useful for diagnosing and fixing network problems.

1. Press **MENU** button - **Main menu** - **System settings** - **Network**, press **SCROLL** knob to confirm.
2. Turn **SCROLL** knob to select your preferred network setting option:

Network wizard	Scan for available networks
PBC Wlan setup	Set up a WPS encrypted network (only support the router uses WPS 2.0)
View settings	View network settings such as MAC address, Wlan region, IP address etc.
Manual settings	Set wireless connection
NetRemote PIN setup	Set a PIN code for setup connection between your radio and smartphone via UNDOK app. The default PIN code is 1234.
Network profile	List of registered networks or press SCROLL knob to delete some unwanted networks
Keep network connected	Keep network connected in DAB, FM, AUX, Bluetooth and standby modes

3. Press **SCROLL** knob to confirm your setting.

Setting Time/Date

1. Press **MENU** button - **Main menu** - **System settings** - **Time/Date**, press **SCROLL** knob to confirm.
2. Turn **SCROLL** knob to select options, and then press **SCROLL** knob to confirm the setting.

Set Time/date	Manually set-up both Time and Date
Auto update	“Update from DAB”, “Update from FM”, “Update from Network” or “No update”
Set format	12 or 24 hour format
Set timezone	Select a timezone (Only available when auto update from Network.)
Daylight saving	Daylight saving settings (Only available when auto update from Network.)

3. Then setting time according to your personal preference.

Setting Language

This feature enables you to change menu language.

1. Press **MENU** button - **Main menu** - **System settings** - **Language**, press **SCROLL** knob to confirm.
2. Turn **SCROLL** knob to select your language, and then press **SCROLL** knob to confirm.

Factory Reset

Doing a factory reset clears all user defined setting, replacing them with the original default values, so time/date, DAB+ station list and preset stations are all lost.

1. Press **MENU** button - **Main menu** - **System settings** - **Factory Reset**, press **SCROLL** knob to confirm.
2. Turn **SCROLL** knob to select “YES”, and then press **SCROLL** knob to confirm.

Software Update – Over the network

From time to time, your radio may make software upgrades available with bug fixes and/or additional features.

If your radio detects that newer software is available, it will ask if you want to go ahead with an update. If you agree, the new software is then downloaded and installed.

After a software upgrade, all user settings are maintained.

C A U T I O N

Before starting a software upgrade, ensure that your radio is plugged into a stable mains power connection. Remove power during a software update may permanently damage the unit.

1. Press **MENU** button - **Main menu** - **System settings** - **Software update**, press **SCROLL** knob to confirm.
2. Turn **SCROLL** knob to select “Auto-check setting”, press **SCROLL** and your radio will check periodically for new version software.
3. Turn **SCROLL** knob to select “Check now”, press **SCROLL** and your radio will now to check new version software and automatically upgrade the detected new version software.

Setup Wizard

When this unit is started for the first time, it runs through a setup wizard to configure settings for date/time and network. Once this has finished, the system is ready to use in most modes.

Redo setup wizard will not erase user settings such as searched stations and presets.

1. Press **MENU** button - **Main menu** - **System settings** - **Setup wizard**, press **SCROLL** knob to confirm.
2. Turn **SCROLL** knob to select “YES”, and then press **SCROLL** knob to confirm. Please refer to page 8 for more information.

Viewing System Info

This information may be requested when dealing with technical support issues.

1. Press **MENU** button - **Main menu** - **System settings** - **Info**, press **SCROLL** knob to confirm.
2. Turn **SCROLL** knob to view “SW version”, “Spotify version”, “Radio ID” and “Friendly Name”.

Setting Backlight

This radio display has a backlight with adjustable brightness level.



1. Press **MENU** button - **Main menu - System settings - Backlight**, press **SCROLL** knob to confirm.
2. Turn **SCROLL** knob to select "Power-on mode" or "Standby Mode", then press **SCROLL** knob to confirm.
3. Turn **SCROLL** knob to select backlight level, and then press **SCROLL** knob to confirm the setting.

Timeout	<ul style="list-style-type: none">• On - During operation, brightness always remains as set in "Power-on Level"• After 1 / 2 / 3 / 4 / 6 / 9 / 12 / 15 minutes, brightness will be set according to "Standby Level"
Power-on Level	<ul style="list-style-type: none">• High• Medium• Low
Standby Level	<ul style="list-style-type: none">• High• Medium• Low

Multiroom (not all models)

Multiroom is a feature that enables you control your radio (one or more) via UNDOK App for playback.

You can enjoy music by using your smartphone or tablet which has UNDOK App to respectively control the radios (multiroom capable devices) in the kitchen, bedroom or living room. Of course you also can group control the radios for playing.

1. To use multiroom feature, download **UNDOK**  app from **App Store** for your iOS smartphone or download from **Google Play** for your Android smartphone.
2. Start UNDOK app, making sure your receiver and smartphone are connected to same WiFi network.
3. All available devices will be listed.
4. Create group, tapping the edit icon  which is following device name in device list, and then “Group Setup” screen will be shown. (Please refer to Fig. 1 and 2.)
 - a. Tap the grey circle before device name which is under “Sharing with” option on “Group setup” screen and make it turn green to add the device to group. (Please refer to Fig. 2.)
 - b. Tap “Rename” under “Group name” option on “Group Setup” screen to enter a group name or select one usual name from the list, and then select “Done” to create group. (Please refer to Fig. 2 and 3.)

 **Note:** tap “Delete group” to delete the group. (Please refer to Fig. 9.)
 - c. Device list will appear again and the group will be shown with group name and the devices in the group. Tap on group name to select the group. (Please refer to Fig. 4.)
 - d. All clients in the group will synchronously play the program which the server is playing. You can drag the volume control bar to change the master volume for all grouped devices. You also can tap on the volume control and then change volume for each device respectively. (Please refer to Fig. 5 and 6.)
 - e. Go to “SOURCE” tab can select another multiroom capable mode from “Multiroom Sources” list to group playing. The modes Aux in and Bluetooth under “Standalone Sources” are not compatible with Multiroom that the master device will be removed from the group to play stand-alone once you selected either mode from “Standalone Sources” list. (Please refer to Fig. 7 and 8.)

 **Note:** master device is the Server in the group which you can check from **Main menu - System settings - Multiroom - View details**.

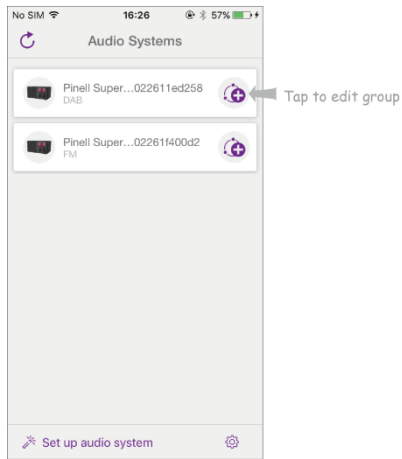

Fig. 1

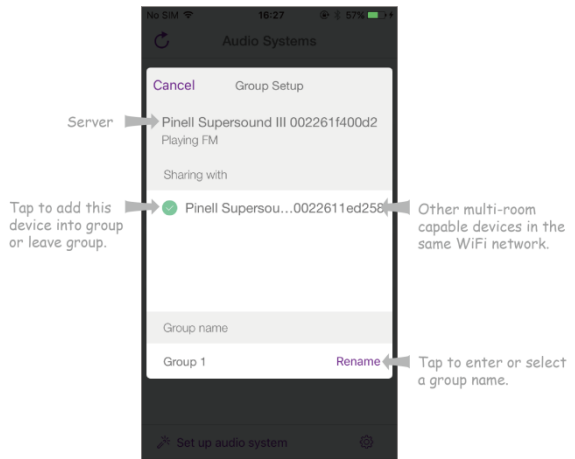

Fig. 2

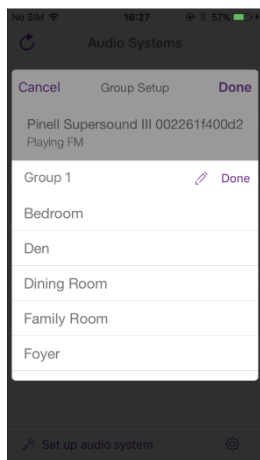

Fig. 3

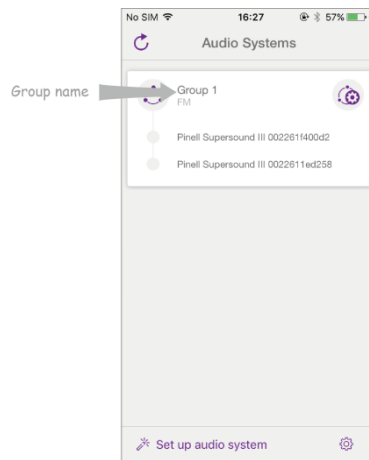

Fig. 4

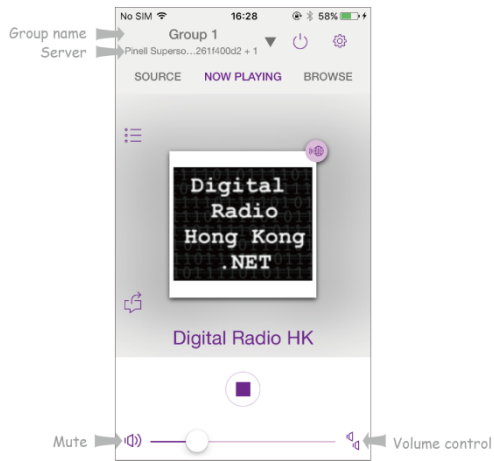

Fig. 5

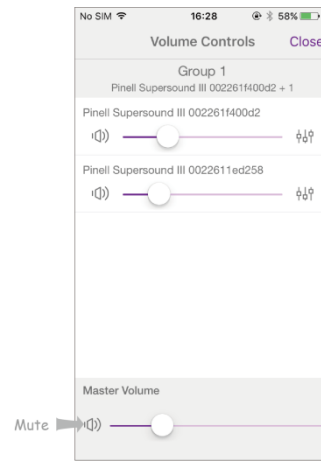

Fig. 6

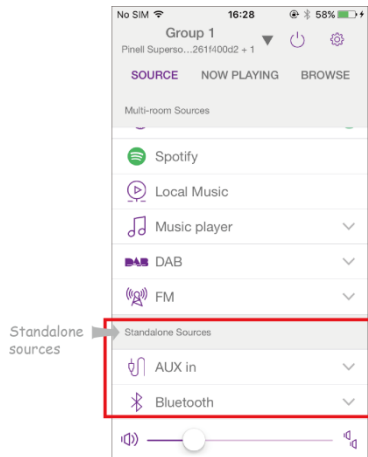

Fig. 7

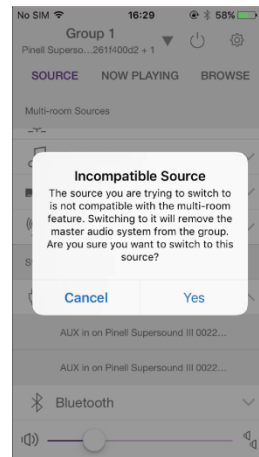

Fig. 8

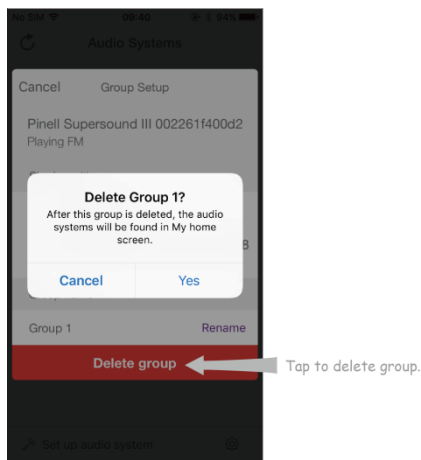

Fig. 9

5. Alternatively, you can edit group through your receiver.
 - a. Press **MENU** button - **Main menu** - **System settings** - **Multiroom**, and then press **SCROLL** knob to confirm.
 - b. Turn **SCROLL** knob to select options, and then press **SCROLL** knob to confirm.

View details	View your radio state (Ungrouped, Server or Client) and the group which it belongs to.
Create new group	Create a new group that your receiver will be added to.
Add to group	Devices in current network will be listed. Select the device you wish to add to the group your receiver belongs to.
List current clients	Clients in the group which your receiver belongs to will be listed. Select a client will remove it from the group.
Leave group	Remove your receiver from the group.
Dissolve group	Dissolve the group which your receiver belongs to.

Troubleshooting

If a problem occurs, it may be due to something very minor. The following table contains various tips.

Problem	Solution
No Power.	<ul style="list-style-type: none">● Ensure the mains cable is properly connected or battery power is not used up.● Make sure that the unit is turned on.
The unit does not respond when pressing any buttons.	<ul style="list-style-type: none">● The unit may freeze up during use. Switch the unit off and then on again to reset it.
Cannot find my network.	<ul style="list-style-type: none">● Make sure the Wi-Fi router is plugged in and working.● Reconnect the radio to your Wi-Fi.● Check you radio is within 5m of your router.
Poor radio reception.	<ul style="list-style-type: none">● Make sure the antenna is fully extended.● Electrical interference in your home can cause poor reception. Move the unit away from them (especially those with motors and transformers).
Desired station not found.	<ul style="list-style-type: none">● Weak signal. Search manually.
I cannot find the radio on my Bluetooth device.	<ul style="list-style-type: none">● Ensure the Bluetooth function is activated on your Bluetooth device.● Re-pair the unit with your Bluetooth device.

If any functional abnormality is encountered, unplug the unit from the mains socket and reconnect it again.

Specifications

<p><u>PLAYS</u></p> <ul style="list-style-type: none"> • DAB/DAB+ • FM (87.5-108MHz PLL) • Internet Radio: more than 30.000 stations worldwide • Bluetooth Streaming • Spotify Connect • Music Player (via UPnP Media Server) <p><u>CONNECTIVITY</u></p> <ul style="list-style-type: none"> • Headset 3.5mm jack • AUX IN 3.5mm jack • WLAN • Multiroom (not all models) 	<p><u>FUNCTIONS</u></p> <ul style="list-style-type: none"> • 5 preset buttons on main unit • 10 preset buttons on remote control • Clock and Dual Alarm • Sleep and Snooze • Menu in 13 languages: EN, DE, DK, NL, FI, FR, IT, NO, PL, PT, ES, SE, TR • Equaliser • Backlight settings • Wireless App – UNDOK • SW upgrade via internet 	<p><u>SOUND</u></p> <ul style="list-style-type: none"> • Speaker: 3.5" bass/mid Mono Coaxial with 1" tweeter • Output: 7 Watt <p><u>DESIGN</u></p> <ul style="list-style-type: none"> • Built in wifi antenna • FM Rod Antenna • Sound-optimised fabric • 2.8" Colour TFT display • Full functional remote control (2x AAA batteries included) • AC 100-240V, 50-60Hz • Power Adaptor DC 12V, 1000mA • Unit dimensions (mm): 250(B) x 145(T) x 138(H) • Weight (kg): 1,8
--	---	---



This symbol on the product or in the instructions means that your electrical and electronic equipment should be disposed at the end of its life separately from your household waste. For more information, please contact the local authority or your retailer where you purchased the product.



TT Micro AS hereby declares that this wireless device is in compliance with the following directives:
2014/53/EU (RED)
2011/65/EU (RoHS)

* Information in this manual is subject to change without notice.

Pinell is a label of TT Micro AS (www.ttmicro.no)
Olav Helsets vei 5, 0694 Oslo, Norway (Email: Support@pinell.no)